

PATIENT MEDICATION INFORMATION

READ THIS FOR SAFE AND EFFECTIVE USE OF YOUR MEDICINE

Pr**SIMPONI**[®] (golimumab)

pronounced sim poe NEE

golimumab injection

Single-use Autoinjector

Read this carefully before you start taking **Simponi** and each time you get a refill. This leaflet is a summary and will not tell you everything about this drug. Talk to your healthcare professional about your medical condition and treatment and ask if there is any new information about **Simponi**.

Serious Warnings and Precautions

- Serious infections, including sepsis, tuberculosis, legionellosis (a serious form of bacterial pneumonia), listeriosis (an infection that usually develops after eating food contaminated by bacteria called listeria) and opportunistic infections (such as systemic fungal and bacterial infections), have been reported in patients receiving Simponi and other similar medicines. Some patients with these infections have died. Prior to treatment with Simponi, you should tell your doctor if you have a chronic infection, a history of recurrent infection, or if you have lived in or travelled to an area where infections called histoplasmosis, coccidioidomycosis or blastomycosis are common. These infections are caused by a fungus that can affect the lungs or other parts of your body. Ask your doctor if you don't know if these infections are common in the area in which you have lived or travelled. If you develop an infection during treatment with Simponi, you should tell your doctor right away.
- Prior to treatment with Simponi, you should tell your doctor if you have had tuberculosis, or if you have been exposed recently to anyone who might have tuberculosis, or if you have any other reason to believe you may be at risk for tuberculosis. Your doctor will evaluate you for tuberculosis and may begin treatment for tuberculosis before you are treated with Simponi.
- Treatment with Simponi must be interrupted if you develop a serious infection or sepsis. Tell your doctor if you have any symptoms of an infection (for example, fever, fatigue, cough, flu-like symptoms, or pain) while you are taking Simponi and for 6 months after you receive the medicine. If you need surgery, tell your doctor that you have taken Simponi.
- Lymphoma and other cancers, which may result in death, have been reported in children and teenage patients taking TNF blockers, of which Simponi is a member.

What is Simponi used for?

Simponi is a prescription medicine that is approved for the treatment of adult patients with rheumatoid arthritis, psoriatic arthritis, ankylosing spondylitis, non-radiographic axial spondyloarthritis, and ulcerative colitis. In these diseases, the body produces too much of a substance called tumour necrosis factor alpha (TNF-alpha). Too much of this substance causes

your body's immune system to attack healthy tissue and results in inflammation. Blocking TNF-alpha with Simponi can reduce inflammation associated with these diseases, but can also reduce your immune system's ability to fight off infections.

- ***Rheumatoid Arthritis***

Rheumatoid arthritis is an inflammatory disease of the joints. If you have active rheumatoid arthritis, you will be given Simponi, which you will take in combination with methotrexate. In patients with rheumatoid arthritis, Simponi may help reduce signs and symptoms of inflammatory arthritis (such as pain), may help improve your ability to do simple daily activities (such as dressing, walking and climbing stairs), and may help prevent damage to your bones and joints.

- ***Psoriatic Arthritis***

Psoriatic arthritis is an inflammatory disease of the joints, usually accompanied by psoriasis. If you have active psoriatic arthritis, you will be given Simponi alone or in combination with methotrexate. In patients with psoriatic arthritis, Simponi may help reduce signs and symptoms of inflammatory arthritis (such as pain), may help improve your ability to do simple daily activities (such as dressing, walking and climbing stairs), and may help to prevent damage to your bones and joints.

- ***Ankylosing Spondylitis***

Ankylosing spondylitis is an inflammatory disease of the spine. If you have active ankylosing spondylitis, you will be given Simponi to reduce the signs and symptoms of your disease.

- ***Non-radiographic axial spondyloarthritis***

Non-radiographic axial spondyloarthritis is an inflammatory disease of the spine. If you have severe, active non-radiographic axial spondyloarthritis, you will be given Simponi to reduce the signs and symptoms of your disease.

- ***Ulcerative Colitis***

Ulcerative colitis (UC) is a chronic inflammatory bowel disorder. In patients with ulcerative colitis, Simponi may

- Reduce the signs and symptoms of your disease
- Induce remission of your disease
- Induce intestinal healing
- Improve your quality of life by helping you feel better
- Maintain control of signs and symptoms of your disease
- Achieve long term remission of your disease

How does Simponi work?

Simponi is a medicine that affects your immune system. Simponi can lower the ability of your immune system to fight infections. Some patients have had serious infections while receiving Simponi, including tuberculosis, and systemic bacterial, and fungal, infections. Some patients have died from these serious infections.

What are the ingredients in Simponi?

Medicinal ingredients: Golimumab

Non-medicinal ingredients:

L-histidine

L-histidine hydrochloride

Polysorbate 80

Sorbitol

Water for injection

No preservatives are present.

Simponi comes in the following dosage forms:

Simponi is available as a single-use autoinjector and as a single-use pre-filled syringe.

Each single-use autoinjector contains either 50 mg golimumab per 0.5 mL, or 100 mg golimumab per 1 mL.

Each single-use pre-filled syringe contains either 50 mg golimumab per 0.5 mL, or 100 mg golimumab per 1 mL.

Do not use Simponi if:

- it is after the expiration date on the label.
- the product is damaged.
- the liquid is discoloured, cloudy or you can see other particulate matter floating in it; Simponi is a clear to slightly clear, colourless to light yellow solution.
- you know, or think that it may have been exposed to extreme temperatures (such as accidentally frozen or heated).
- you have a severe infection, such as sepsis (an infection in the bloodstream), abscess, tuberculosis or other serious infection.
- you have heart failure that is moderate or severe.
- you are allergic to golimumab, latex or any other ingredient (polysorbate 80 or sorbitol) in the formulation or component of the container.

To help avoid side effects and ensure proper use, talk to your healthcare professional before you take Simponi. Talk about any health conditions or problems you may have, including if you:

- have any kind of infection even if it is very minor.
- have an infection that won't go away or a history of infection that keeps coming back.
- have had TB (tuberculosis), or have recently been near anyone who might have TB. Your doctor will evaluate you for TB and perform a skin or blood test. If your doctor feels that you are at risk for TB, he or she may start treating you for TB before you begin Simponi therapy.
- have or have had a hepatitis B infection.
- have heart failure, or if you previously had or currently have any heart condition. If you develop new or worsening symptoms of heart failure, such as shortness of breath or swelling of your feet, you must notify your doctor.
- have or have had a condition that affects your nervous system, like multiple sclerosis or Guillain-Barré syndrome. You should tell your doctor if you experience weakness in your arms or legs, numbness, tingling, or visual disturbances.
- have or have had any type of cancer.
- have recently received or are scheduled to receive a vaccine.

- have recently received or are scheduled to receive treatment with a therapeutic infectious agent (such as BCG instillation used for the treatment of cancer).
- have a latex allergy.
- are pregnant, planning to become pregnant, or breastfeeding. Simponi should only be used during pregnancy if clearly needed. If you are being treated with Simponi, you must avoid becoming pregnant by using adequate contraception during your treatment and for 6 months after your last Simponi injection. Women who are breastfeeding should talk to their doctor about whether or not to use Simponi.
- received Simponi while you were pregnant as your baby may be at higher risk of getting an infection. It is Important to tell your baby's doctor and other health professionals about your Simponi use before the baby receives any vaccine as certain vaccines may put your baby at higher risk of infections.

Tell your healthcare professional about all the medicines you take, including any drugs, vitamins, minerals, natural supplements or alternative medicines. These include any other medicines to treat rheumatoid arthritis, psoriatic arthritis, ankylosing spondylitis, non-radiographic axial spondyloarthritis, or ulcerative colitis.

The following may interact with Simponi:

- prescription and non-prescription medicines, vitamins, and herbal supplements.
- Kineret (anakinra) or Orencia (abatacept) or other immunosuppressant medications. Simponi should not be taken together with anakinra or abatacept. Also, tell your doctor if you are taking other medications that affect your immune system.

Keep a list of all your medications with you to show your doctor and pharmacist each time you get a new medicine.

How to take Simponi:

Where I May Receive Training on How to Self-Inject Simponi:

The BioAdvance® Network has been established to offer training on how to self-inject Simponi. Patients can be trained by BioAdvance® qualified healthcare professionals either at their home or at BioAdvance® clinics located across Canada. Contact your doctor if you have any questions.

PROPER USE OF THIS MEDICATION

- For rheumatoid arthritis, psoriatic arthritis, ankylosing spondylitis, and non-radiographic axial spondyloarthritis Simponi 50 mg is given by injection under the skin (subcutaneously) with an autoinjector or a pre-filled syringe once a month, on the same date each month.
- If you are receiving Simponi for ulcerative colitis, all injections will be given subcutaneously. You will receive your first 200 mg dose followed by an additional 100 mg dose 2 weeks after the first dose. You will receive a 50 mg or 100 mg dose every 4 weeks thereafter as directed by your doctor.
- **Simponi is intended for use under the guidance and supervision of your doctor.** Your doctor will tell you how often to take Simponi. **Do not take Simponi more often than prescribed.**
- If your doctor determines that it is appropriate, you may be able to administer Simponi to yourself, after proper training in injection technique. If you would like to self-inject Simponi using the Simponi SmartJect® Autoinjector, do not inject into the arm and do not pinch the

skin while injecting (see **INSTRUCTIONS FOR INJECTING SIMPONI USING A SINGLE-USE SmartJect® AUTOINJECTOR**).

- If you take more Simponi than you were told to take, call your doctor.
- Do not miss any doses of Simponi (See *Missed dose*).

INSTRUCTIONS FOR INJECTING SIMPONI USING A SINGLE-USE SmartJect® AUTOINJECTOR

If you would like to self-inject Simponi, you must be trained by a healthcare professional to prepare an injection and give it to yourself. If you have not been trained, please contact your healthcare professional to schedule a training session.

Note: A two-handed method is recommended when injecting with the SmartJect® autoinjector. Please see **STEP 3** below, for instructions.

STEP 1: PREPARING TO USE THE SmartJect® AUTOINJECTOR

The diagram below shows what the autoinjector looks like:

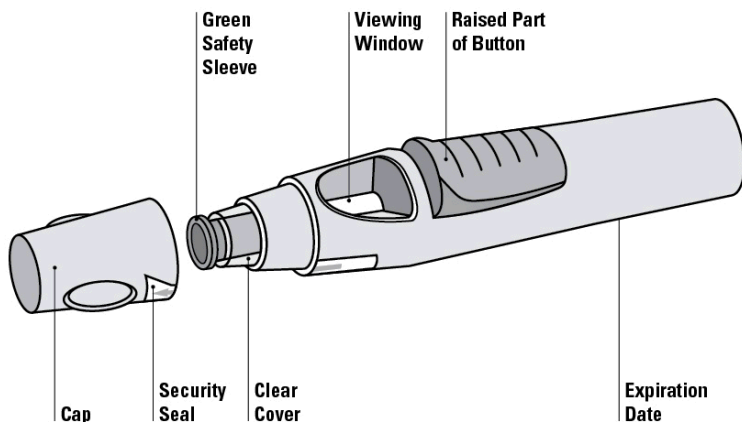

Do **NOT** shake the autoinjector at any time.

Do **NOT** remove the autoinjector cap until instructed to do so.

Do **NOT** put the autoinjector cap back on if removed to avoid bending the needle.

Check Expiration Date

- Check the expiration date (indicated as “EXP”) on the autoinjector.
- You can also check the expiration date printed on the carton.
- If the expiration date has passed, or if the autoinjector has been kept at room temperature 25°C [77°F] for longer than 30 days or if the autoinjector has been stored above 25°C [77°F], do **NOT** use the autoinjector. Please contact your doctor or pharmacist or call 1-800-567-3331 (Canada only) for assistance.

Check Security Seal

- Check the security seal around the cap of the autoinjector. If the security seal is broken, do **NOT** use the autoinjector and please contact your doctor or pharmacist or call 1-800-567-3331 (Canada only) for assistance.

Wait 30 Minutes

- To ensure proper injection, allow the autoinjector to sit at room temperature outside the carton for 30 minutes out of the reach of children.



Do **NOT** warm the autoinjector in any other way (for example, Do **NOT** warm it in a microwave or in hot water).

Do **NOT** remove the autoinjector cap while allowing it to reach room temperature.

Assemble Additional Supplies

- Assemble additional supplies you will need for your injection. These include an alcohol swab, a cotton ball or gauze, and a sharps container.

Check the Liquid in the SmartJect® Autoinjector

- Look through the viewing window to make sure that the liquid in the autoinjector is clear to slightly opalescent and colourless to slightly yellow.
- You may also notice an air bubble – this is normal.

Do **NOT** use if the liquid is discoloured, cloudy or contains particles. If this is the case, please contact your doctor or pharmacist or call 1-800-567-3331 (Canada only) for assistance.

STEP 2: CHOOSING AND PREPARING THE INJECTION SITE (SmartJect® AUTOINJECTOR)

Choose the Injection Site

Select from the following areas for your injection:

- Front of the middle thighs, or
- Lower abdomen below the belly button, except for the two-inch area directly underneath the belly button.
- Do **NOT** inject into the arm.
- Injection sites should be rotated. At the time of dosing, if multiple injections are required, the injections should be administered at different injection sites on the body.

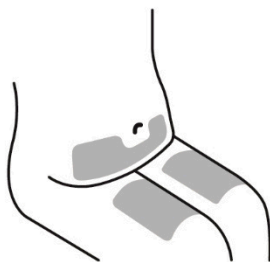

 Injectable areas

 **DO NOT** inject into the arm to avoid failure of the device and/or unintentional injury. Do **NOT** inject into areas where the skin is tender, bruised, red, scaly or hard. Avoid areas with scars or stretch marks.

Wash Hands and Clean Injection Site

- Thoroughly wash your hands with soap and warm water.
- Wipe the injection site with an alcohol swab.

Do **NOT** touch this area again before giving the injection. Allow the skin to dry before injecting. Do **NOT** fan or blow on the clean area.

STEP 3: INJECTING Simponi USING THE SINGLE-USE SmartJect® AUTOINJECTOR

Remove the Cap

The cap should **NOT** be removed until you are ready to inject the medication. The medication should be injected within 5 minutes after the cap has been removed.

- When you are ready to inject, twist the cap slightly to break the security seal.
- Pull the cap off and immediately place the cap into the trash.

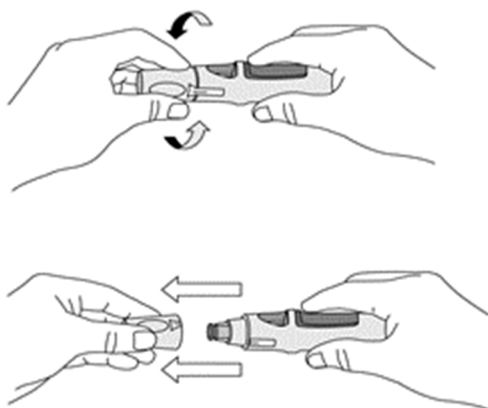

Do **NOT** put the cap back on because it may damage the needle inside the autoinjector.

Note: Do not use the autoinjector if it is dropped without the cap in place. If you drop the autoinjector without the cap in place, please contact your doctor, pharmacist or call 1-800-567-3331 (Canada only) for assistance.

Push the SmartJect® Autoinjector Against the Skin Without Pinching the Skin

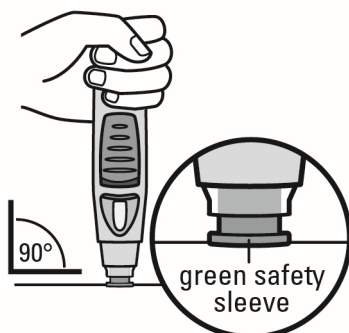

- Hold the autoinjector comfortably with one hand **above the blue button**.
- Make sure the green safety sleeve is stable and is as flat as possible against your skin. If the device is not stable during the injection, you risk bending the needle.
- Do **NOT** pinch the skin to avoid unintentional needlestick injury.

- Do **NOT** touch or press the blue button while positioning the autoinjector onto your skin.

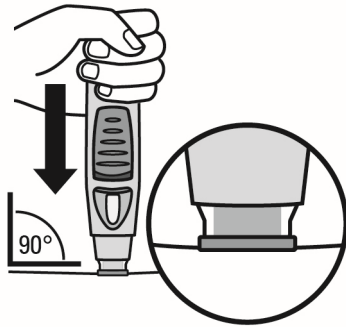

- Push the open end of the autoinjector against the skin at a 90-degree angle. Apply enough pressure to slide the green safety sleeve up and to maintain it inside the clear cover. Only the wider portion of the green safety sleeve remains outside of the clear cover.
- Do **NOT** press the button until **after** the safety sleeve slides into the clear cover. Pushing the blue button before the safety sleeve is depressed can lead to device failure.
- Do **NOT** pinch the skin at any point during injection.

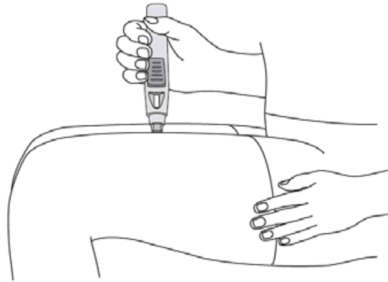

Note: A two-handed method is recommended when injecting with the SmartJect[®] autoinjector

Press Button to Inject

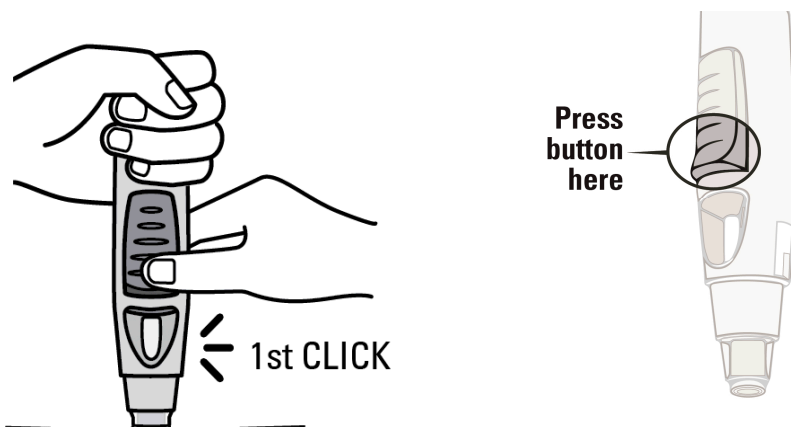

- Continue to hold the autoinjector against the skin. **Use your other hand to** press the front **raised part of the button** to start your injection. Do not press the button unless the autoinjector is pressed against your skin and the safety sleeve slides into the clear cover.

- Once the button is pressed, it will remain pressed in so you do not need to keep pressure on it.
- Tip: If the button seems hard to depress, don't press the button harder. Let go of the button, then lift the autoinjector and start again. Ensure no pressure is on the button until the green safety sleeve is fully depressed against the skin, then press the button.
- **You will hear a loud 'click' sound – don't be alarmed.** The first loud "click" indicates that the needle has been inserted and the injection has started. You may or may not feel a needle prick at this time.

Do NOT lift the autoinjector away from your skin. If you pull the autoinjector away from the skin, you may not get your full dose of medicine.

Wait for Second "Click", it usually takes about 3 to 6 seconds, but may take up to 15 seconds for you to hear the second 'Click' sound.

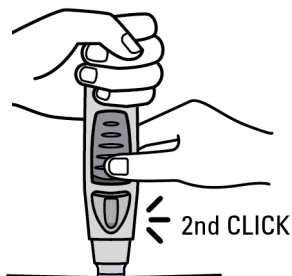

- **Continue to hold the autoinjector against the skin until you hear the second "click" (indicating that the injection has finished and the needle has retracted into the autoinjector).**
- Lift the autoinjector from the injection site.

Note: If you do not hear the second 'click', wait 15 seconds from the time you first press the button and then lift the autoinjector from the injection site.

STEP 4: AFTER THE INJECTION

Check the Viewing Window

- After injecting, check the viewing window to make sure that the yellow indicator is visible.
- This indicates that the autoinjector has worked properly.
- The yellow indicator may not fill the entire viewing window. This is normal.
- If you do not think you received your injection, check the yellow indicator again to confirm that the dose was delivered.
- If the yellow indicator is not visible in the viewing window, call 1-800-567-3331 (Canada only) for assistance. Do **NOT** administer a second dose without speaking to your doctor.

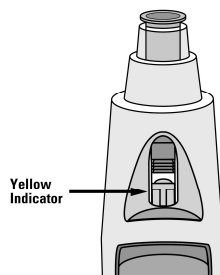

Disposing of the SmartJect® Autoinjector

- Immediately dispose of the autoinjector in the sharps container.
- Dispose of the sharps container according to your local regulations when the container is full.



Use Cotton Ball or Gauze

- There may be a small amount of blood or liquid at the injection site, which is normal.
 - You can press a cotton ball or gauze over the injection site for 10 seconds.
- Do **NOT** rub the injection site.
- You may cover the injection site with a small adhesive bandage, if necessary.

Usual dose:

Rheumatoid Arthritis, Psoriatic Arthritis, Ankylosing Spondylitis and Non-radiographic axial spondyloarthritis

50 mg of Simponi given as a subcutaneous injection once a month, on the same date each month.

Ulcerative Colitis

200 mg of Simponi given as a subcutaneous injection at Week 0, followed by 100 mg at Week 2 and then 50 or 100 mg every 4 weeks, thereafter. Your doctor may consider doing a blood test (therapeutic drug monitoring) to determine how much golimumab is in your blood stream in order to optimize your dose of Simponi.

Overdose:

Single doses up to 10 mg/kg intravenously have been administered in a clinical study without any direct toxic effect. In case of overdosage, it is recommended that the patient be monitored for any signs or symptoms of adverse effects and appropriate symptomatic treatment be instituted immediately.

If you think you, or a person you are caring for, have taken too much Simponi, contact a healthcare professional, hospital emergency department, or regional poison control centre immediately, even if there are no symptoms.

Missed dose:

Patients who miss a dose of Simponi, should be advised to inject this missed dose as soon as they become aware of it, and then follow with their next scheduled dose.

If you are not sure what to do, talk to your doctor or pharmacist.

What are possible side effects from using Simponi?

These are not all the possible side effects you may have when taking Simponi. If you experience any side effects not listed here, tell your healthcare professional.

The common side effects with Simponi include flu, bronchitis, infection of soft tissues, sore throat, upper respiratory infection, sinus infection, runny nose, cold sores, abnormal liver tests, dizziness, numbness or tingling, high blood pressure, fever, hair loss, and redness at the site of injection.

Serious side effects that may require treatment can occur during Simponi therapy. Possible serious side effects of Simponi include:

Serious Infections

(See **How does Simponi work?**) If you develop a fever, chills, headache, flu-like symptoms, feel tired, have a cough, blood in your sputum, shortness of breath, night sweats, weight loss, nausea, vomiting, diarrhea, frequency or burning while passing urine, redness or swelling of skin or joint, cold sores, tooth pain or new or worsening of pain in any location while or after receiving Simponi, you should tell your doctor right away because these could be signs that you are getting an infection.

Treatment with TNF-blocking agents such as Simponi may result in reactivation of the hepatitis B virus in patients who carry this virus. If you know or suspect you may be a carrier of hepatitis B virus, be sure to tell your doctor about this as this may impact the decision to start or continue treatment with Simponi. Your doctor should do a blood test for hepatitis B virus before you start treatment with Simponi.

Allergic Reactions

Some patients may get allergic reactions to Simponi. Some reactions may be serious, and in rare instances, life-threatening. Some of these reactions occurred after the first administration of Simponi. Symptoms of an allergic reaction may include hives, rash, difficulty breathing, chest pain, and high or low blood pressure. You should contact your doctor if you experience any of these symptoms.

Needle Cover with Dry Natural Rubber (a form of latex)

The needle cover on the pre-filled syringe and the autoinjector contains dry natural rubber (a form of latex). This may cause allergic reactions in people who are sensitive to latex. Tell your doctor if you have ever had an allergic reaction to latex or developed any allergic reaction to Simponi injection.

Injection Site Reactions

Some patients develop reactions at the injection site at their skin after Simponi injections. These reactions may include mild rash, swelling, bruising, hives, pain, numbness, and irritation. You should contact your doctor if you experience severe symptoms at injection site.

Cancer

In clinical studies, reports of blood cancer called lymphoma were more frequent in patients on Simponi than expected for people in general. People who have been treated for rheumatoid

arthritis, psoriatic arthritis or ankylosing spondylitis for a long time, particularly those with highly active disease may be more prone to develop lymphoma. Cancers, other than lymphoma, have also been reported in patients treated with Simponi or other TNF-blockers. In a study of Simponi in patients with severe, persistent asthma, cancers occurred in Simponi-treated patients but not in control-treated patients. If you have severe, persistent asthma, you should discuss with your doctor whether Simponi is appropriate for you. Some patients treated with Simponi have developed certain kinds of skin cancer like melanoma. If any changes in the appearance of the skin or growths on the skin occur during or after therapy, tell your doctor.

There have been cases of cancers, including unusual types, in children and teenage patients taking TNF-blocking agents, which sometimes resulted in death. For children and adults taking TNF-blocker medicines, the chances of developing lymphoma or other cancers may increase.

Rarely, a specific and severe type of lymphoma called Hepatosplenic T-cell lymphoma has been observed in patients taking other TNF-blockers, of which Simponi is a member. Most of these patients were adolescent or young adult males. This type of cancer has usually resulted in death. Almost all of these patients were being treated for Crohn's disease or ulcerative colitis with a TNF-blocker and had also received drugs known as azathioprine or 6-mercaptopurine. Tell your doctor if you are taking IMURAN (azathioprine) or PURINETHOL (6-mercaptopurine) with Simponi.

You should also tell your doctor if you have had or develop lymphoma or other cancers while you are taking Simponi. Whether you decide to use Simponi or not, you should discuss with your doctor the cancer screening measures and impact of lifestyle choices on the risk of developing cancer.

Congestive Heart Failure

Cases of worsening congestive heart failure (CHF) and new onset CHF have been reported with TNF-blocking agents, including Simponi. Some of these patients died. Simponi has not been studied in patients with CHF. Tell your doctor if you have heart failure. If you have mild heart failure and your doctor decides to administer Simponi, your condition should be closely monitored during treatment. If you develop new or worsening symptoms of heart failure (such as shortness of breath or swelling of your feet), you should contact your doctor right away.

Neurological Events

In rare instances patients treated with TNF-blocking agents may develop diseases such as multiple sclerosis or Guillain-Barré syndrome. Tell your doctor if you have a history of a neurological disease. If you develop symptoms of neurological disease, such as changes in your vision, weakness in your arms or legs, or numbness or tingling in any part of your body, you should contact your doctor right away.

Blood Problems

In some instances, patients treated with TNF-blocking agents may develop low blood counts. If you develop symptoms such as persistent fever, bleeding, or bruising, you should contact your doctor right away.

Vaccinations

You should not receive certain vaccines while using Simponi. If you have recently received or are scheduled to receive a vaccine, please inform your doctor.

Certain vaccinations may cause infections. If you received Simponi while you were pregnant, your baby may be at higher risk for getting such an infection for up to approximately six months after the last dose you received during pregnancy. It is important to tell your baby's doctor and other health care professionals about your Simponi use so they can decide when your baby should receive any vaccine.

Liver Problems

There have been cases where patients taking Simponi developed liver problems. Signs that you could be having a problem include: skin and eyes turning yellow, dark brown-coloured urine, right-sided abdominal pain, fever, nausea, vomiting, and severe fatigue. You should contact your doctor right away if you experience these symptoms.

Driving and Using Machines

Simponi may have a minor influence on your ability to drive and use machines. Dizziness may occur following administration of Simponi. If this happens, do not drive or use any tools or machines.

Serious side effects and what to do about them			
Symptom / effect	Talk to your healthcare professional		Stop taking drug and get immediate medical help
	Only if severe	In all cases	
COMMON			
Serious infections: fever, chills, headache, flu-like symptoms, feel tired, have a cough, blood in your sputum, shortness of breath, night sweats, weight loss, nausea, vomiting, diarrhea, frequency or burning while passing urine, redness or swelling of skin or joint, cold sores, tooth pain or new or worsening of pain in any location while or after receiving Simponi		✓	✓
UNCOMMON			
Allergic reactions: hives, rash, difficulty breathing, chest pain, high or low blood pressure		✓	
Injection site reactions: rash, swelling, bruising, hives, pain, numbness, and irritation		✓	
Neurological events: changes in your vision, weakness in your arms or legs, numbness or tingling in any part of your body		✓	
Appendicitis		✓	

Serious side effects and what to do about them			
Symptom / effect	Talk to your healthcare professional		Stop taking drug and get immediate medical help
	Only if severe	In all cases	
RARE			
Itchy reddish-purple skin rash and/or threadlike white-grey lines on mucous membranes (lichenoid reactions)		✓	

If you have a troublesome symptom or side effect that is not listed here or becomes bad enough to interfere with your daily activities, tell your healthcare professional.

<p>Reporting Side Effects</p> <p>You can report any suspected side effects associated with the use of health products to Health Canada by:</p> <ul style="list-style-type: none"> • Visiting the Web page on Adverse Reaction Reporting (https://www.canada.ca/en/health-canada/services/drugs-health-products/medeffect-canada.html) for information on how to report online, by mail or by fax; or • Calling toll-free at 1-866-234-2345. <p><i>NOTE: Contact your health professional if you need information about how to manage your side effects. The Canada Vigilance Program does not provide medical advice.</i></p>
--

Storage:

If you are using Simponi at home, it is important that it is stored in your refrigerator at 2–8 °C (36–46°F) although not in the freezer compartment. Simponi should not be frozen. Keep the product in the original carton to protect from light until the time of use. Do not shake.

When needed, for example when you are travelling, Simponi may also be stored at room temperature up to a maximum of 25°C (77 °F) for a single period up to 30 days in the original carton. Be sure to protect from light until time of use. Once removed from the refrigerator for room temperature storage, it should not be refrigerated again. Simponi should be discarded if not used within 30 days after removal from the refrigerator. It is recommended that you record the room temperature expiration date on the carton after which date Simponi should be discarded.

Always keep medicine out of the reach and sight of children.

If you want more information about Simponi:

- Talk to your healthcare professional
- Find the full product monograph that is prepared for healthcare professionals and includes this Patient Medication Information by visiting the Health Canada website:

(<https://www.canada.ca/en/health-canada/services/drugs-health-products/drug-products/drug-product-database.html>; www.janssen.com/canada, or by calling 1-800-567-3331 or 1-800-387-8781.

Information about the BioAdvance® Network can be obtained by contacting Janssen Inc. Medical Information at 1-800-567-3331.

This leaflet was prepared by Janssen Inc., Toronto, Ontario M3C 1L9

Last revised: January 2024

© 2024 Janssen Inc.

All trademarks used under license.

All other third party trademarks are trademarks of their respective owners.

PATIENT MEDICATION INFORMATION

READ THIS FOR SAFE AND EFFECTIVE USE OF YOUR MEDICINE

Pr**SIMPONI**[®] (golimumab)

pronounced sim poe NEE

golimumab injection

Single-use Pre-filled Syringe

Read this carefully before you start taking **Simponi** and each time you get a refill. This leaflet is a summary and will not tell you everything about this drug. Talk to your healthcare professional about your medical condition and treatment and ask if there is any new information about **Simponi**.

Serious Warnings and Precautions

- Serious infections, including sepsis, tuberculosis, legionellosis (a serious form of bacterial pneumonia), listeriosis (an infection that usually develops after eating food contaminated by bacteria called listeria) and opportunistic infections (such as systemic fungal and bacterial infections), have been reported in patients receiving Simponi and other similar medicines. Some patients with these infections have died. Prior to treatment with Simponi, you should tell your doctor if you have a chronic infection, a history of recurrent infection, or if you have lived in or travelled to an area where infections called histoplasmosis, coccidioidomycosis or blastomycosis are common. These infections are caused by a fungus that can affect the lungs or other parts of your body. Ask your doctor if you don't know if these infections are common in the area in which you have lived or travelled. If you develop an infection during treatment with Simponi, you should tell your doctor right away.
- Prior to treatment with Simponi, you should tell your doctor if you have had tuberculosis or if you have been exposed recently to anyone who might have tuberculosis, or if you have any other reason to believe you may be at risk for tuberculosis. Your doctor will evaluate you for tuberculosis and may begin treatment for tuberculosis before you are treated with Simponi.
- Treatment with Simponi must be interrupted if you develop a serious infection or sepsis. Tell your doctor if you have any symptoms of an infection (for example, fever, fatigue, cough, flu-like symptoms, or pain) while you are taking Simponi and for 6 months after you receive the medicine. If you need surgery, tell your doctor that you have taken Simponi.
- Lymphoma and other cancers, which may result in death, have been reported in children and teenage patients taking TNF blockers, of which Simponi is a member.

What is Simponi used for?

Simponi is a prescription medicine that is approved for the treatment of adult patients with rheumatoid arthritis, psoriatic arthritis, ankylosing spondylitis, non-radiographic axial spondyloarthritis, and ulcerative colitis. In these diseases, the body produces too much of a substance called tumor necrosis factor alpha (TNF-alpha). Too much of this substance causes your body's immune system to attack healthy tissue and results in inflammation. Blocking TNF-

alpha with Simponi can reduce inflammation associated with these diseases, but can also reduce your immune system's ability to fight off infections.

- **Rheumatoid Arthritis**

Rheumatoid arthritis is an inflammatory disease of the joints. If you have active rheumatoid arthritis, you will be given Simponi, which you will take in combination with methotrexate. In patients with rheumatoid arthritis, Simponi may help reduce signs and symptoms of inflammatory arthritis (such as pain), may help improve your ability to do simple daily activities (such as dressing, walking and climbing stairs), and may help prevent damage to your bones and joints.

- **Psoriatic Arthritis**

Psoriatic arthritis is an inflammatory disease of the joints, usually accompanied by psoriasis. If you have active psoriatic arthritis, you will be given Simponi alone or in combination with methotrexate. In patients with psoriatic arthritis, Simponi may help reduce signs and symptoms of inflammatory arthritis (such as pain), may help improve your ability to do simple daily activities (such as dressing, walking and climbing stairs), and may help to prevent damage to your bones and joints.

- **Ankylosing Spondylitis**

Ankylosing spondylitis is an inflammatory disease of the spine. If you have active ankylosing spondylitis, you will be given Simponi to reduce the signs and symptoms of your disease.

- **Non-radiographic axial spondyloarthritis**

Non-radiographic axial spondyloarthritis is an inflammatory disease of the spine. If you have severe, active non-radiographic axial spondyloarthritis, you will be given Simponi to reduce the signs and symptoms of your disease.

- **Ulcerative Colitis**

Ulcerative colitis (UC) is a chronic inflammatory bowel disorder. In patients with ulcerative colitis, Simponi may

- Reduce the signs and symptoms of your disease
- Induce remission of your disease
- Induce intestinal healing
- Improve your quality of life by helping you feel better
- Maintain control of signs and symptoms of your disease
- Achieve long term remission of your disease

How does Simponi work?

Simponi is a medicine that affects your immune system. Simponi can lower the ability of your immune system to fight infections. Some patients have had serious infections while receiving Simponi, including tuberculosis, and systemic bacterial, and fungal, infections. Some patients have died from these serious infections.

What are the ingredients in Simponi?

Medicinal ingredients: Golimumab

Non-medicinal ingredients:

L-histidine

L-histidine hydrochloride

Polysorbate 80

Sorbitol

Water for injection

No preservatives are present.

Simponi comes in the following dosage forms:

Simponi is available as a single-use autoinjector and as a single-use pre-filled syringe.

Each single-use autoinjector contains either 50 mg golimumab per 0.5 mL, or 100 mg golimumab per 1 mL.

Each single-use pre-filled syringe contains either 50 mg golimumab per 0.5 mL, or 100 mg golimumab per 1 mL.

Do not use Simponi if:

- it is after the expiration date on the label.
- the product is damaged.
- the liquid is discoloured, cloudy or you can see other particulate matter floating in it; Simponi is a clear to slightly clear, colourless to light yellow solution.
- you know, or think that it may have been exposed to extreme temperatures (such as accidentally frozen or heated).
- you have a severe infection, such as sepsis (an infection in the bloodstream), abscess, tuberculosis or other serious infection.
- you have heart failure that is moderate or severe.
- you are allergic to golimumab, latex or any other ingredient (polysorbate 80 or sorbitol) in the formulation or component of the container.

To help avoid side effects and ensure proper use, talk to your healthcare professional before you take Simponi. Talk about any health conditions or problems you may have, including if you:

- have any kind of infection even if it is very minor.
- have an infection that won't go away or a history of infection that keeps coming back.
- have had TB (tuberculosis), or have recently been near anyone who might have TB. Your doctor will evaluate you for TB and perform a skin or blood test. If your doctor feels that you are at risk for TB, he or she may start treating you for TB before you begin Simponi therapy
- have or have had a hepatitis B infection.
- have heart failure, or if you previously had or currently have any heart condition. If you develop new or worsening symptoms of heart failure, such as shortness of breath or swelling of your feet, you must notify your doctor.
- have or have had a condition that affects your nervous system, like multiple sclerosis or Guillain-Barré syndrome. You should tell your doctor if you experience weakness in your arms or legs, numbness, tingling, or visual disturbances.
- have or have had any type of cancer.
- have recently received or are scheduled to receive a vaccine.
- have recently received or are scheduled to receive treatment with a therapeutic infectious agent (such as BCG instillation used for the treatment of cancer).

- have a latex allergy.
- are pregnant, planning to become pregnant, or breastfeeding. Simponi should only be used during pregnancy if clearly needed. If you are being treated with Simponi, you must avoid becoming pregnant by using adequate contraception during your treatment and for 6 months after your last Simponi injection. Women who are breastfeeding should talk to their doctor about whether or not to use Simponi.
- received Simponi while you were pregnant as your baby may be at higher risk of getting an infection. It is important to tell your baby's doctor and other health professionals about your Simponi use before the baby receives any vaccine as certain vaccines may put your baby at higher risk of infections.

Tell your healthcare professional about all the medicines you take, including any drugs, vitamins, minerals, natural supplements or alternative medicines. These include any other medicines to treat rheumatoid arthritis, psoriatic arthritis, ankylosing spondylitis, non-radiographic axial spondyloarthritis, or ulcerative colitis.

The following may interact with Simponi:

- prescription and non-prescription medicines, vitamins, and herbal supplements.
- Kineret (anakinra) or Orencia (abatacept) or other immunosuppressant medications. Simponi should not be taken together with anakinra or abatacept. Also, tell your doctor if you are taking other medications that affect your immune system.

Keep a list of all your medications with you to show your doctor and pharmacist each time you get a new medicine.

How to take Simponi:

Where I May Receive Training on How to Self-Inject Simponi:

The BioAdvance® Network has been established to offer training on how to self-inject Simponi. Patients can be trained by BioAdvance® qualified healthcare professionals either at their home or at BioAdvance® clinics located across Canada. Contact your doctor if you have any questions.

PROPER USE OF THIS MEDICATION

- For rheumatoid arthritis, psoriatic arthritis, ankylosing spondylitis, and non-radiographic axial spondyloarthritis Simponi 50 mg is given by injection under the skin (subcutaneously) with an autoinjector or a pre-filled syringe once a month, on the same date each month.
- If you are receiving Simponi for ulcerative colitis, all injections will be given subcutaneously. You will receive your first 200 mg dose followed by an additional 100 mg dose 2 weeks after the first dose. You will receive a 50 mg or 100 mg dose every 4 weeks thereafter as directed by your doctor.
- Simponi is intended for use under the guidance and supervision of your doctor. Your doctor will tell you how often to take Simponi. **Do not take Simponi more often than prescribed.** If your doctor determines that it is appropriate, you may be able to administer Simponi to yourself, after proper training in injection technique (see **INSTRUCTIONS FOR INJECTING SIMPONI USING A PRE-FILLED SYRINGE**).
- If you take more Simponi than you were told to take, call your doctor.
- Do not miss any doses of Simponi. (See *Missed dose*).

INSTRUCTIONS FOR INJECTING SIMPONI USING A PRE-FILLED SYRINGE

If you would like to self-inject Simponi, you must be trained by a healthcare professional to prepare an injection and give it to yourself. If you have not been trained, please contact your healthcare professional to schedule a training session.

STEP 1: PREPARING TO USE THE PRE-FILLED SYRINGE

The diagram below shows what the pre-filled syringe looks like:

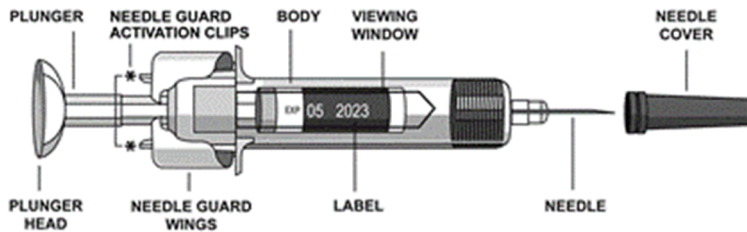

Hold the pre-filled syringe by the body of the syringe.

DO NOT hold the pre-filled syringe by the plunger head, plunger, needle guard wings, or needle cover.

DO NOT pull back on the plunger at any time.

DO NOT shake the pre-filled syringe at any time.

DO NOT remove the needle cover from the pre-filled syringe until instructed to do so.

DO NOT touch the needle guard activation clips (as indicated by asterisks [*] in the first illustration) to prevent prematurely covering the needle with the needle guard.

Check the Expiration Date

- Check the expiration date (as indicated by “EXP”) on the label by looking through the viewing window located within the body of the pre-filled syringe
- If you cannot see the expiration date through the viewing window, hold the pre-filled syringe by its body and rotate the needle cover to line up the expiration date to the viewing window
- You can also check the expiration date printed on the carton
- If the expiration date has passed, or if the pre-filled syringe has been kept at room temperature 25°C (77°F) for longer than 30 days or if the pre-filled syringe has been stored above 25°C (77°F) **DO NOT** use the pre-filled syringe. Please contact your doctor or pharmacist or call 1-800-567-3331 (Canada only) for assistance.



Wait 30 Minutes

- To ensure proper injection, allow the pre-filled syringe to sit at room temperature outside of the carton for 30 minutes out of the reach of children



DO NOT warm the pre-filled syringe in any other way. (For example, **DO NOT** warm it in a microwave or in hot water.)

DO NOT remove the pre-filled syringe needle cover while allowing it to reach room temperature.

Assemble Additional Supplies

- Assemble additional supplies you will need for your injection. These include an alcohol swab, a cotton ball or gauze, and a sharps container for syringe disposal

Check the Liquid in the Pre-filled Syringe

- Hold the pre-filled syringe by its body with the covered needle pointing downward
- Look at the liquid through the viewing window of the pre-filled syringe to make sure that it is clear to slightly opalescent and colourless to slightly yellow
- If you cannot see the liquid through the viewing window, hold the pre-filled syringe by its body and rotate the needle cover to line up the liquid to the viewing window
- You may also notice an air bubble – this is normal

DO NOT use if the liquid is discoloured, cloudy or contains particles. If this is the case, please contact your doctor or pharmacist or call 1-800-567-3331 (Canada only) for assistance.

STEP 2: CHOOSING AND PREPARING THE INJECTION SITE FOR THE PRE-FILLED SYRINGE

Choose the Injection Site

- The recommended injection site is the front of the middle thighs
- You can also use the lower abdomen below the belly button, except for the two-inch area directly underneath the belly button
- If a caregiver is giving you the injection, the caregiver can also use the outer area of the upper arms
- Injection sites should be rotated. At the time of dosing, if multiple injections are required, the injections should be administered at different sites on the body.

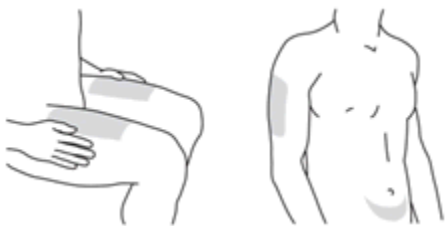

DO NOT inject into areas where the skin is tender, bruised, red, scaly or hard. Avoid areas with scars or stretch marks.

Preparing the Injection Site

- Thoroughly wash your hands with soap and warm water
- Wipe the injection site with an alcohol swab

DO NOT touch this area again before giving the injection. Allow the skin to dry before injecting.
DO NOT fan or blow on the clean area.

STEP 3: INJECTING THE MEDICATION USING THE PRE-FILLED SYRINGE

The needle cover should **NOT** be removed until you are ready to inject the medication. The medication should be injected within 5 minutes after the needle cover has been removed.

Remove the Needle Cover

DO NOT touch the plunger during needle cover removal.

- When you are ready to inject, hold the body of the pre-filled syringe with one hand, and pull the needle cover straight off
- Place the needle cover into the trash
- You may notice an air bubble in the pre-filled syringe. You **DO NOT** need to remove the air bubble
- You may also see a drop of liquid at the end of the needle – this is normal

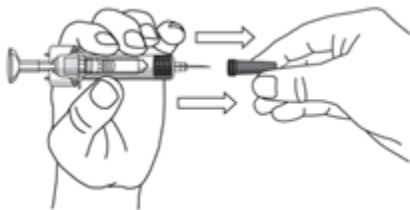

DO NOT touch the needle or allow it to touch any surface.

DO NOT use the pre-filled syringe if it is dropped without the needle cover in place. If you drop the pre-filled syringe without the needle cover in place, please contact your doctor, pharmacist or call 1-800-567-3331 (Canada only) for assistance.

Position the Syringe and Inject the Medication

- Hold the body of the pre-filled syringe in one hand between the middle and index fingers and place the thumb on top of the plunger head



DO NOT pull back on the plunger at any time

- Use the other hand to gently pinch the area of skin that you previously cleaned. Hold firmly
- Place the needle at approximately a 45-degree angle to the pinched skin. In a single and swift motion, insert the needle through the skin as far as it will go
- Inject all of the medication by pushing in the plunger until the plunger head is completely between the needle guard wings

- When the plunger is pushed as far as it will go, continue to keep the pressure on the plunger head, take out the needle and let go of the skin
- Slowly take your thumb off the plunger head to allow the empty syringe to move up until the entire needle is covered by the needle guard as shown by the illustration

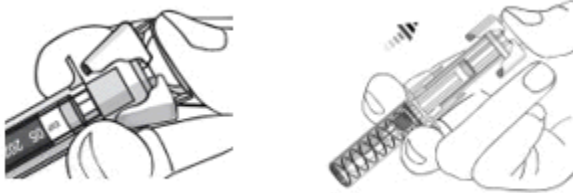

STEP 4: AFTER THE INJECTION

Disposing of the Empty Syringe

- Immediately dispose of the empty syringe into the sharps container. For your safety and health and for the safety of others, needles and empty syringes **must NEVER** be re-used
- Dispose of the sharps container according to your local regulations



Use Cotton Ball or Gauze

- There may be a small amount of blood or liquid at the injection site, which is normal
- You can press a cotton ball or gauze over the injection site and hold for 10 seconds

DO NOT rub the injection site.

- You may cover the injection site with a small adhesive bandage, if necessary

Usual dose:

Rheumatoid Arthritis, Psoriatic Arthritis, Ankylosing Spondylitis and Non-radiographic axial spondyloarthritis

50 mg of Simponi given as a subcutaneous injection once a month, on the same date each month.

Ulcerative Colitis

200 mg of Simponi given as a subcutaneous injection at Week 0, followed by 100 mg at Week 2 and then 50 mg or 100 mg every 4 weeks, thereafter. Your doctor may consider doing a blood test (therapeutic drug monitoring) to determine how much golimumab is in your blood stream in order to optimize your dose of Simponi.

Overdose:

Single doses up to 10 mg/kg intravenously have been administered in a clinical study without any direct toxic effect. In case of overdosage, it is recommended that the patient be monitored for any signs or symptoms of adverse effects and appropriate symptomatic treatment be instituted immediately.

If you think you, or a person you are caring for, have taken too much Simponi, contact a healthcare professional, hospital emergency department, or regional poison control centre immediately, even if there are no symptoms.

Missed dose:

Patients who miss a dose of Simponi, should be advised to inject this missed dose as soon as they become aware of it, and then follow with their next scheduled dose. If you are not sure what to do, talk to your doctor or pharmacist.

What are possible side effects from using Simponi?

These are not all the possible side effects you may have when taking Simponi. If you experience any side effects not listed here, tell your healthcare professional.

The common side effects with Simponi include flu, bronchitis, infection of soft tissues, sore throat, upper respiratory infection, sinus infection, runny nose, cold sores, abnormal liver tests, dizziness, numbness or tingling, high blood pressure, fever, hair loss and redness at the site of injection.

Serious side effects that may require treatment can occur during Simponi therapy. Possible serious side effects of Simponi include:

Serious Infections

(See **How does Simponi work?**). If you develop a fever, chills, headache, flu-like symptoms, feel tired, have a cough, blood in your sputum, shortness of breath, night sweats, weight loss, nausea, vomiting, diarrhea, frequency or burning while passing urine, redness or swelling of skin or joint, cold sores, tooth pain or new or worsening of pain in any location while or after receiving Simponi, you should tell your doctor right away because these could be signs that you are getting an infection.

Treatment with TNF-blocking agents such as Simponi may result in reactivation of the hepatitis B virus in patients who carry this virus. If you know or suspect you may be a carrier of hepatitis B virus, be sure to tell your doctor about this as this may impact the decision to start or continue treatment with Simponi. Your doctor should do a blood test for hepatitis B virus before you start treatment with Simponi.

Allergic Reactions

Some patients may get allergic reactions to Simponi. Some reactions may be serious, and in rare instances, life-threatening. Some of these reactions occurred after the first administration of Simponi. Symptoms of an allergic reaction may include hives, rash, difficulty breathing, chest pain, and high or low blood pressure. You should contact your doctor if you experience any of these symptoms.

Needle Cover with Dry Natural Rubber (a form of latex)

The needle cover on the pre-filled syringe and the autoinjector contains dry natural rubber (a form of latex). This may cause allergic reactions in people who are sensitive to latex. Tell your doctor if you have ever had an allergic reaction to latex or developed any allergic reaction to Simponi injection.

Injection Site Reactions

Some patients develop reactions at the injection site at their skin after Simponi injections. These reactions may include mild rash, swelling, bruising, hives, pain, numbness, and irritation. You should contact your doctor if you experience severe symptoms at injection site.

Cancer

In clinical studies, reports of blood cancer called lymphoma were more frequent in patients on Simponi than expected for people in general. People who have been treated for rheumatoid arthritis, psoriatic arthritis or ankylosing spondylitis for a long time, particularly those with highly active disease may be more prone to develop lymphoma. Cancers, other than lymphoma, have also been reported in patients treated with Simponi or other TNF-blockers. In a study of Simponi in patients with severe, persistent asthma, cancers occurred in Simponi-treated patients but not in control treated patients. If you have severe, persistent asthma you should discuss with your doctor whether Simponi is appropriate for you. Some patients treated with Simponi have developed certain kinds of skin cancer like melanoma. If any changes in the appearance of the skin or growths on the skin occur during or after therapy, tell your doctor.

There have been cases of cancers, including unusual types, in children and teenage patients taking TNF-blocking agents, which sometimes resulted in death. For children and adults taking TNF-blocker medicines, the chances of developing lymphoma or other cancers may increase.

Rarely, a specific and severe type of lymphoma called Hepatosplenic T-cell lymphoma has been observed in patients taking other TNF-blockers, of which Simponi is a member. Most of these patients were adolescent or young adult males. This type of cancer has usually resulted in death. Almost all of these patients were being treated for Crohn's disease or ulcerative colitis with a TNF-blocker and had also received drugs known as azathioprine or 6-mercaptopurine. Tell your doctor if you are taking IMURAN (azathioprine) or PURINETHOL (6-mercaptopurine) with Simponi.

You should also tell your doctor if you have had or develop lymphoma or other cancers while you are taking Simponi. Whether you decide to use Simponi or not, you should discuss with your doctor the cancer screening measures and impact of lifestyle choices on the risk of developing cancer.

Congestive Heart Failure

Cases of worsening congestive heart failure (CHF) and new onset CHF have been reported with TNF-blocking agents, including

Simponi. Some of these patients died. Simponi has not been studied in patients with CHF. Tell your doctor if you have heart failure. If you have mild heart failure and your doctor decides to administer Simponi, your condition should be closely monitored during treatment. If you develop new or worsening symptoms of heart failure (such as shortness of breath or swelling of your feet), you should contact your doctor right away.

Neurological Events

In rare instances patients treated with TNF-blocking agents may develop diseases such as multiple sclerosis or Guillain-Barré syndrome. Tell your doctor if you have a history of a neurological disease. If you develop symptoms of neurological disease such as changes in your vision, weakness in your arms or legs, or numbness or tingling in any part of your body, you should contact your doctor right away.

Blood Problems

In some instances, patients treated with TNF-blocking agents may develop low blood counts. If you develop symptoms such as persistent fever, bleeding, or bruising, you should contact your doctor right away.

Vaccinations

You should not receive certain vaccines while using Simponi. If you have recently received or are scheduled to receive a vaccine, please inform your doctor.

Certain vaccinations may cause infections. If you received Simponi while you were pregnant, your baby may be at higher risk for getting such an infection for up to approximately six months after the last dose you received during pregnancy. It is important to tell your baby's doctor and other health care professionals about your Simponi use so they can decide when your baby should receive any vaccine.

Liver Problems

There have been cases where patients taking Simponi developed liver problems. Signs that you could be having a problem include: skin and eyes turning yellow, dark brown-coloured urine, right-sided abdominal pain, fever, nausea, vomiting, and severe fatigue. You should contact your doctor right away if you experience these symptoms.

Driving and Using Machines

Simponi may have a minor influence on your ability to drive and use machines. Dizziness may occur following administration of Simponi. If this happens, do not drive or use any tools or machines.

Serious side effects and what to do about them			
Symptom / effect	Talk to your healthcare professional		Stop taking drug and get immediate medical help
	Only if severe	In all cases	
COMMON			
Serious infections: fever, chills, headache, flu-like symptoms, feel tired, have a cough, blood in your sputum, shortness of breath, night sweats, weight loss, nausea, vomiting, diarrhea, frequency or burning while passing urine, redness or swelling of skin or joint, cold sores, tooth pain or new or worsening of pain in any location while or after receiving Simponi		✓	✓
UNCOMMON			
Allergic reactions: hives, rash, difficulty breathing, chest pain, high or low blood pressure		✓	
Injection site reactions: rash, swelling, bruising, hives, pain, numbness, and irritation		✓	
Neurological events: changes in your vision, weakness in your arms or legs, numbness or tingling in any part of your body		✓	
Appendicitis		✓	
RARE			
Itchy reddish-purple skin rash and/or threadlike white-grey lines on mucous membranes (lichenoid reactions)		✓	

If you have a troublesome symptom or side effect that is not listed here or becomes bad enough to interfere with your daily activities, tell your healthcare professional.

Reporting Side Effects

You can report any suspected side effects associated with the use of health products to Health Canada by:

- Visiting the Web page on Adverse Reaction Reporting (<https://www.canada.ca/en/health-canada/services/drugs-health-products/medeffect-canada.html>) for information on how to report online, by mail or by fax; or
- Calling toll-free at 1-866-234-2345.

NOTE: Contact your health professional if you need information about how to manage your side effects. The Canada Vigilance Program does not provide medical advice.

Storage:

If you are using Simponi at home, it is important that it is stored in your refrigerator at 2–8 °C (36–46°F) although not in the freezer compartment. Simponi should not be frozen. Keep the product in the original carton to protect from light until the time of use. Do not shake.

When needed, for example when you are travelling, Simponi may also be stored at room temperature up to a maximum of 25°C (77 °F) for a single period up to 30 days in the original carton. Be sure to protect from light until time of use. Once removed from the refrigerator for room temperature storage, it should not be refrigerated again. Simponi should be discarded if not used within 30 days after removal from the refrigerator. It is recommended that you record the room temperature expiration date on the carton after which date Simponi should be discarded.

Always keep medicine out of the reach and sight of children.

If you want more information about Simponi:

- Talk to your healthcare professional
- Find the full product monograph that is prepared for healthcare professionals and includes this Patient Medication Information by visiting the Health Canada website: (<https://www.canada.ca/en/health-canada/services/drugs-health-products/drug-products/drug-product-database.html>; www.janssen.com/canada, or by calling 1-800-567-3331 or 1-800-387-8781. Information about the BioAdvance® Network can be obtained by contacting Janssen Inc. at: 1-800-567-3331.

This leaflet was prepared by Janssen Inc., Toronto, Ontario M3C 1L9

Last revised: January 2024

© 2024 Janssen Inc.

All trademarks used under license.

All other third party trademarks are trademarks of their respective owners.

PATIENT MEDICATION INFORMATION

READ THIS FOR SAFE AND EFFECTIVE USE OF YOUR MEDICINE

Pr**SIMPONI**[®] I.V. (golimumab)

pronounced sim poe NEE
golimumab for injection

Single-use Vial

Read this carefully before you start taking **Simponi I.V.** and each time you get a refill. This leaflet is a summary and will not tell you everything about this drug. Talk to your healthcare professional about your medical condition and treatment and ask if there is any new information about **Simponi I.V.**

Serious Warnings and Precautions

- Serious infections, including sepsis, tuberculosis, legionellosis (a serious form of bacterial pneumonia), listeriosis (an infection that usually develops after eating food contaminated by bacteria called listeria) and opportunistic infections (such as systemic fungal and bacterial infections), have been reported in patients receiving Simponi I.V. and other similar medicines. Some patients with these infections have died. Prior to treatment with Simponi I.V., you should tell your doctor if you have a chronic infection, a history of recurrent infection, or if you have lived in or travelled to an area where infections called histoplasmosis, coccidioidomycosis or blastomycosis are common. These infections are caused by a fungus that can affect the lungs or other parts of your body. Ask your doctor if you don't know if these infections are common in the area in which you have lived or travelled. If you develop an infection during treatment with Simponi I.V., you should tell your doctor right away.
- Prior to treatment with Simponi I.V., you should tell your doctor if you have had tuberculosis, or if you have been exposed recently to anyone who might have tuberculosis, or if you have any other reason to believe you may be at risk for tuberculosis. Your doctor will evaluate you for tuberculosis and may begin treatment for tuberculosis before you are treated with Simponi I.V.
- Treatment with Simponi I.V. must be interrupted if you develop a serious infection or sepsis. Tell your doctor if you have any symptoms of an infection (for example, fever, fatigue, cough, flu-like symptoms, or pain) while you are taking Simponi I.V. and for 6 months after you receive the medicine. If you need surgery, tell your doctor that you have taken Simponi I.V.
- Lymphoma and other cancers, which may result in death, have been reported in children and teenage patients taking TNF blockers, of which Simponi I.V. is a member.

What is Simponi I.V. used for?

Simponi I.V. is a prescription medicine that is approved for the treatment of adult patients with rheumatoid arthritis, psoriatic arthritis and ankylosing spondylitis and children with polyarticular juvenile idiopathic arthritis. In these diseases, the body produces too much of a substance

called tumour necrosis factor alpha (TNF-alpha). Too much of this substance causes your body's immune system to attack healthy tissue and results in inflammation. Blocking TNF-alpha with Simponi I.V. can reduce inflammation associated with this disease, but can also reduce your immune system's ability to fight off infections.

- **Rheumatoid Arthritis**

Rheumatoid arthritis is an inflammatory disease of the joints. If you have active rheumatoid arthritis, you will be given Simponi I.V., which you will take in combination with methotrexate. In patients with rheumatoid arthritis, Simponi I.V. may help reduce signs and symptoms of inflammatory arthritis (such as pain).

- **Psoriatic Arthritis**

Simponi I.V. is a prescription medicine that is approved for adults with active psoriatic arthritis.

Psoriatic arthritis is an inflammatory disease of the joints, usually accompanied by psoriasis. If you have active psoriatic arthritis that has not responded to other medications and you are an adult, you may be given Simponi I.V., alone or in combination with methotrexate, to help reduce signs and symptoms of inflammatory arthritis (such as pain), improve your ability to do simple daily activities (such as dressing, walking and climbing stairs), prevent damage to your bones and joints and improve your psoriasis.

- **Ankylosing Spondylitis**

Simponi I.V. is a prescription medicine that is approved for adults with ankylosing spondylitis.

Ankylosing spondylitis is an inflammatory disease of the spine. If you have ankylosing spondylitis that has not responded to other medications and you are an adult, you may be given Simponi I.V. to reduce the signs and symptoms of your disease and improve your ability to do simple daily activities (such as dressing, walking and climbing stairs).

- **Polyarticular Juvenile Idiopathic Arthritis**

Simponi I.V., alone or in combination with methotrexate, is a prescription medicine that is approved for children 2 years of age and older with active polyarticular juvenile idiopathic arthritis.

Polyarticular juvenile idiopathic arthritis is an inflammatory disease that causes joint pain and swelling in children. If your child has polyarticular juvenile idiopathic arthritis, your child will first be given other medicines. If your child does not respond well enough to these medicines, your child will be given Simponi I.V. to treat the disease.

How does Simponi I.V. work?

Simponi I.V. is a medicine that affects your immune system. Simponi I.V. can lower the ability of your immune system to fight infections. Some patients have had serious infections while receiving Simponi I.V., including tuberculosis, and systemic bacterial, and fungal, infections. Some patients have died from these serious infections.

What are the ingredients in Simponi I.V.?

Medicinal ingredients: Golimumab

Non-medicinal ingredients:

L-histidine

L-histidine monohydrochloride monohydrate

Polysorbate 80

Sorbitol

Water for injection

No preservatives are present.

Simponi I.V. comes in the following dosage forms:

Simponi I.V. is available as a sterile solution in single-use vials.

Each 4 mL vial of Simponi I.V. contains 50 mg golimumab.

Do not use Simponi I.V. if:

- it is after the expiration date on the label.
- the product is damaged.
- the liquid is discoloured, cloudy or you can see other particulate matter floating in it; Simponi I.V. is a clear, colourless to light yellow solution.
- you know, or think that it may have been exposed to extreme temperatures (such as accidentally frozen or heated).
- you have a severe infection, such as sepsis (an infection in the bloodstream), abscess, tuberculosis or other serious infection.
- you have heart failure that is moderate or severe.
- you are allergic to golimumab, latex or any other ingredient (polysorbate 80 or sorbitol) in the formulation or component of the container.

To help avoid side effects and ensure proper use, talk to your healthcare professional before you take Simponi I.V. Talk about any health conditions or problems you may have, including if you:

- have any kind of infection even if it is very minor.
- have an infection that won't go away or a history of infection that keeps coming back.
- have had tuberculosis, or have recently been near anyone who might have tuberculosis. Your doctor will evaluate you for tuberculosis and perform a skin or a blood test. If your doctor feels that you are at risk for tuberculosis, he or she may start treating you for tuberculosis before you begin Simponi I.V. therapy.
- have or have had a hepatitis B infection.
- have heart failure, or if you previously had or currently have any heart condition. If you develop new or worsening symptoms of heart failure, such as shortness of breath or swelling of your feet, you must notify your doctor.
- have or have had a condition that affects your nervous system, like multiple sclerosis or Guillain-Barré syndrome. You should tell your doctor if you experience weakness in your arms or legs, numbness, tingling, or visual disturbances.
- have or have had any type of cancer.
- have recently received or are scheduled to receive a vaccine.
- have recently received or are scheduled to receive treatment with a therapeutic infectious agent (such as BCG instillation used for the treatment of cancer).
- are pregnant, planning to become pregnant, or breastfeeding. Simponi I.V. should only be used during pregnancy if clearly needed. If you are being treated with Simponi I.V.,

you must avoid becoming pregnant by using adequate contraception during your treatment and for 6 months after your last Simponi I.V. infusion. Women who are breastfeeding should talk to their doctor about whether or not to use Simponi I.V.

- received Simponi I.V. while you were pregnant as your baby may be at higher risk of getting an infection. It is important to tell your baby's doctor and other health professionals about your Simponi I.V. use before the baby receives any vaccine as certain vaccines may put your baby at higher risk of infections.

Tell your healthcare professional about all the medicines you take, including any drugs, vitamins,

minerals, natural supplements or alternative medicines. These include any other medicines to treat rheumatoid arthritis, psoriatic arthritis, ankylosing spondylitis, or polyarticular juvenile idiopathic arthritis.

The following may interact with Simponi I.V.:

- prescription and non-prescription medicines, vitamins, and herbal supplements.
- Kineret (anakinra) or Orencia (abatacept) or other immunosuppressant medications. Simponi I.V. should not be taken together with anakinra or abatacept. Also, tell your doctor if you are taking other medications that affect your immune system.

Keep a list of all your medications with you to show your doctor and pharmacist each time you get a new medicine.

How to take Simponi I.V.:

PROPER USE OF THIS MEDICATION

- Simponi I.V. will be given to you by a doctor or nurse. The doctor or nurse will prepare the Simponi I.V. solution for intravenous infusion.
- The Simponi I.V. solution will be given through a needle placed in a vein usually in an arm. The infusion will take approximately 30 minutes.

Usual dose:

Rheumatoid Arthritis, Psoriatic Arthritis or Ankylosing Spondylitis

- Your doctor will decide your dose (in mg) based on your weight. The dose is 2 mg for every kg of body weight. The table below shows how often you will usually have this medicine.

1 st treatment	Initial treatment
2 nd treatment	4 weeks after your 1 st treatment
Further treatments	Every 8 weeks

Polyarticular Juvenile Idiopathic Arthritis

- Simponi I.V. will be given to your child by a doctor or nurse. The doctor or nurse will prepare the Simponi I.V. solution for intravenous infusion.
- The Simponi I.V. solution will be given through a needle placed in a vein usually in the arm. The infusion will take approximately 30 minutes.
- Your child's doctor will decide the dose based on your child's height and weight. The table below shows how often your child will usually have this medicine.

1 st treatment	Initial treatment
2 nd treatment	4 weeks after your 1 st treatment
Further treatments	Every 8 weeks

Overdose:

Single doses up to 10 mg/kg intravenously have been administered in a clinical study without any direct toxic effect. In case of overdosage, it is recommended that the patient be monitored for any signs or symptoms of adverse effects and appropriate symptomatic treatment be instituted immediately.

If you think you, or a person you are caring for, have taken too much Simponi I.V., contact a healthcare professional, hospital emergency department, or regional poison control centre immediately, even if there are no symptoms.

Missed dose:

If you forget or miss an appointment to receive Simponi I.V., make another appointment as soon as possible.

What are possible side effects from using Simponi I.V.?

These are not all the possible side effects you may have when taking Simponi I.V. If you experience any side effects not listed here, tell your healthcare professional.

The most common side effects with Simponi I.V. include: flu, bronchitis, infection of soft tissues, sore throat, upper respiratory infection, sinus infection, runny nose, cold sores, abnormal liver tests, dizziness, numbness or tingling, high blood pressure, fever, hair loss and redness at the site of injection.

Serious side effects that may require treatment can occur during Simponi I.V. therapy. Possible serious side effects of Simponi I.V. include:

Serious Infections

(See **How does Simponi I.V. work?**) If you develop a fever, chills, headache, flu-like symptoms, feel tired, have a cough, blood in your sputum, shortness of breath, night sweats, weight loss, nausea, vomiting, diarrhea, frequency or burning while passing urine, redness or swelling of skin or joint, cold sores, tooth pain or new or worsening of pain in any location while or after receiving Simponi I.V., you should tell your doctor right away because these could be signs that you are getting an infection.

Treatment with TNF-blocking agents such as Simponi I.V. may result in reactivation of the hepatitis B virus in patients who carry this virus. If you know or suspect you may be a carrier of hepatitis B virus, be sure to tell your doctor about this as this may impact the decision to start or continue treatment with Simponi I.V. Your doctor should do a blood test for hepatitis B virus before you start treatment with Simponi I.V.

Allergic Reactions

Some patients may get allergic reactions to Simponi I.V. Some reactions may be serious, and in rare instances, life-threatening. Some of these reactions occurred after the first administration of Simponi I.V. Symptoms of an allergic reaction may include hives, rash, difficulty breathing, chest

pain, and high or low blood pressure. You should contact your doctor if you experience any of these symptoms. If an allergic reaction occurs while getting a Simponi I.V. infusion or shortly afterwards, your doctor may decide to stop your Simponi I.V. infusion and/or give you medication to treat the reaction.

Cancer

In clinical studies, reports of a blood cancer called lymphoma were more frequent in patients on Simponi administered subcutaneously than expected for people in general. People who have been treated for rheumatoid arthritis, psoriatic arthritis or ankylosing spondylitis for a long time, particularly those with highly active disease may be more prone to develop lymphoma. Cancers, other than lymphoma, have also been reported in patients treated with Simponi I.V. or other TNF-blockers. In a study of Simponi administered subcutaneously in patients with severe, persistent asthma, cancers occurred in Simponi-treated patients but not in control-treated patients. If you have severe, persistent asthma, you should discuss with your doctor whether Simponi I.V. is appropriate for you. Some patients treated with Simponi I.V. have developed certain kinds of skin cancer like melanoma. If any changes in the appearance of the skin or growths on the skin occur during or after therapy, tell your doctor.

There have been cases of cancers, including unusual types, in children and teenage patients taking TNF-blocking agents, which sometimes resulted in death. For children and adults taking TNF-blocker medicines, the chances of developing lymphoma or other cancers may increase.

Rarely, a specific and severe type of lymphoma called hepatosplenic T-cell lymphoma has been observed in patients taking other TNF-blockers, of which Simponi I.V. is a member. Most of these patients were adolescent or young adult males. This type of cancer has usually resulted in death. Almost all of these patients were being treated for Crohn's disease or ulcerative colitis with a TNF-blocker and had also received drugs known as azathioprine or 6-mercaptopurine. Tell your doctor if you are taking IMURAN (azathioprine) or PURINETHOL (6-mercaptopurine) with Simponi I.V.

You should also tell your doctor if you have had or develop lymphoma or other cancers while you are taking Simponi I.V. Whether you decide to use Simponi I.V. or not, you should discuss with your doctor the cancer screening measures and impact of lifestyle choices on the risk of developing cancer.

Congestive Heart Failure

Cases of worsening congestive heart failure (CHF) and new onset CHF have been reported with TNF-blocking agents, including Simponi I.V. Some of these patients died. Simponi I.V. has not been studied in patients with CHF. Tell your doctor if you have heart failure. If you have mild heart failure and your doctor decides to administer Simponi I.V., your condition should be closely monitored during treatment. If you develop new or worsening symptoms of heart failure (such as shortness of breath or swelling of your feet), you should contact your doctor right away.

Neurological Events

In rare instances patients treated with TNF-blocking agents may develop diseases such as multiple sclerosis or Guillain-Barré syndrome. Tell your doctor if you have a history of a neurological disease. If you develop symptoms of neurological disease such as changes in your vision, weakness in your arms or legs, numbness or tingling in any part of your body, you should contact your doctor right away.

Blood Problems

In some instances, patients treated with TNF-blocking agents may develop low blood counts. Low blood counts have been seen with Simponi I.V. If you develop symptoms such as persistent fever, bleeding, or bruising, you should contact your doctor right away.

Vaccinations

You should not receive certain vaccines while using Simponi I.V. If you have recently received or are scheduled to receive a vaccine, please inform your doctor.

Certain vaccinations may cause infections. If you received Simponi I.V. while you were pregnant, your baby may be at higher risk for getting such an infection for up to approximately six months after the last dose you received during pregnancy. It is important to tell your baby's doctor and other health care professionals about your Simponi I.V. use so they can decide when your baby should receive any vaccine.

Talk to your child's doctor regarding vaccinations for your child. If possible, your child should be up to date with all vaccinations before using Simponi I.V.

Liver Problems

There have been cases where patients taking Simponi I.V. developed liver problems. Signs that you could be having a problem include: skin and eyes turning yellow, dark brown-coloured urine, right-sided abdominal pain, fever, nausea, vomiting, and severe fatigue. You should contact your doctor right away if you experience these symptoms.

Driving and Using Machines

Simponi I.V. may have a minor influence on your ability to drive and use machines. Dizziness may occur following administration of Simponi I.V. If this happens, do not drive or use any tools or machines.

Serious side effects and what to do about them			
Symptom / effect	Talk to your healthcare professional		Stop taking drug and get immediate medical help
	Only if severe	In all cases	
COMMON (≥1% and <10%)			
Serious infections: fever, chills, headache, flu-like symptoms, feel tired, have a cough, blood in your sputum, shortness of breath, night sweats, weight loss, nausea, vomiting, diarrhea, frequency or burning while passing urine, redness or swelling of skin or joint, cold sores, tooth pain or new or worsening of pain in any location while or after receiving Simponi I.V.		✓	✓
Infusion reactions: rash, swelling, bruising, hives, pain, numbness, and irritation		✓	
UNCOMMON (≥0.1% and <1%)			
Allergic reactions: hives, rash, difficulty breathing, chest pain, high or low blood pressure		✓	
Neurological events: changes in your vision, weakness in your arms or legs, numbness or tingling in any part of your body		✓	
Anemia (low red blood cells)		✓	
Appendicitis		✓	
RARE			
Itchy reddish-purple skin rash and/or threadlike white-grey lines on mucous membranes (lichenoid reactions)		✓	

If you have a troublesome symptom or side effect that is not listed here or becomes bad enough to interfere with your daily activities, tell your healthcare professional.

Reporting Side Effects

You can report any suspected side effects associated with the use of health products to Health Canada by:

- Visiting the Web page on Adverse Reaction Reporting (<https://www.canada.ca/en/health-canada/services/drugs-health-products/medeffect-canada.html>) for information on how to report online, by mail or by fax; or
- Calling toll-free at 1-866-234-2345.

NOTE: Contact your health professional if you need information about how to manage your side effects. The Canada Vigilance Program does not provide medical advice.

Storage:

Simponi I.V. must be stored in the original package in the refrigerator before use. Simponi I.V. should not be frozen. It must be kept out of the reach and sight of children. Keep the product in the original carton to protect from light until the time of use. Do not shake.

When needed, for example when you are travelling, Simponi I.V. may also be stored at room temperature up to a maximum of 25°C (77 °F) for a single period up to 30 days in the original carton. Be sure to protect from light until time of use. Once removed from the refrigerator for room temperature storage, it should not be refrigerated again. Simponi I.V. should be discarded if not used within 30 days after removal from the refrigerator. It is recommended that you record the room temperature expiration date on the carton after which date Simponi I.V. should be discarded.

If you want more information about Simponi I.V.:

- Talk to your healthcare professional
- Find the full product monograph that is prepared for healthcare professionals and includes this Patient Medication Information by visiting the Health Canada website: (<https://www.canada.ca/en/health-canada/services/drugs-health-products/drug-products/drug-product-database.html>; www.janssen.com/canada, or by calling 1-800-567-3331 or 1-800-387-8781.

This leaflet was prepared by Janssen Inc., Toronto, Ontario M3C 1L9

Last revised: January 2024

© 2024 Janssen Inc.

All trademarks used under license.

All other third party trademarks are trademarks of their respective owners.